Fitting instructions

Make: Mitsubishi
Grandis; 2004->

Type: 4169

Permanently

linked to

quality

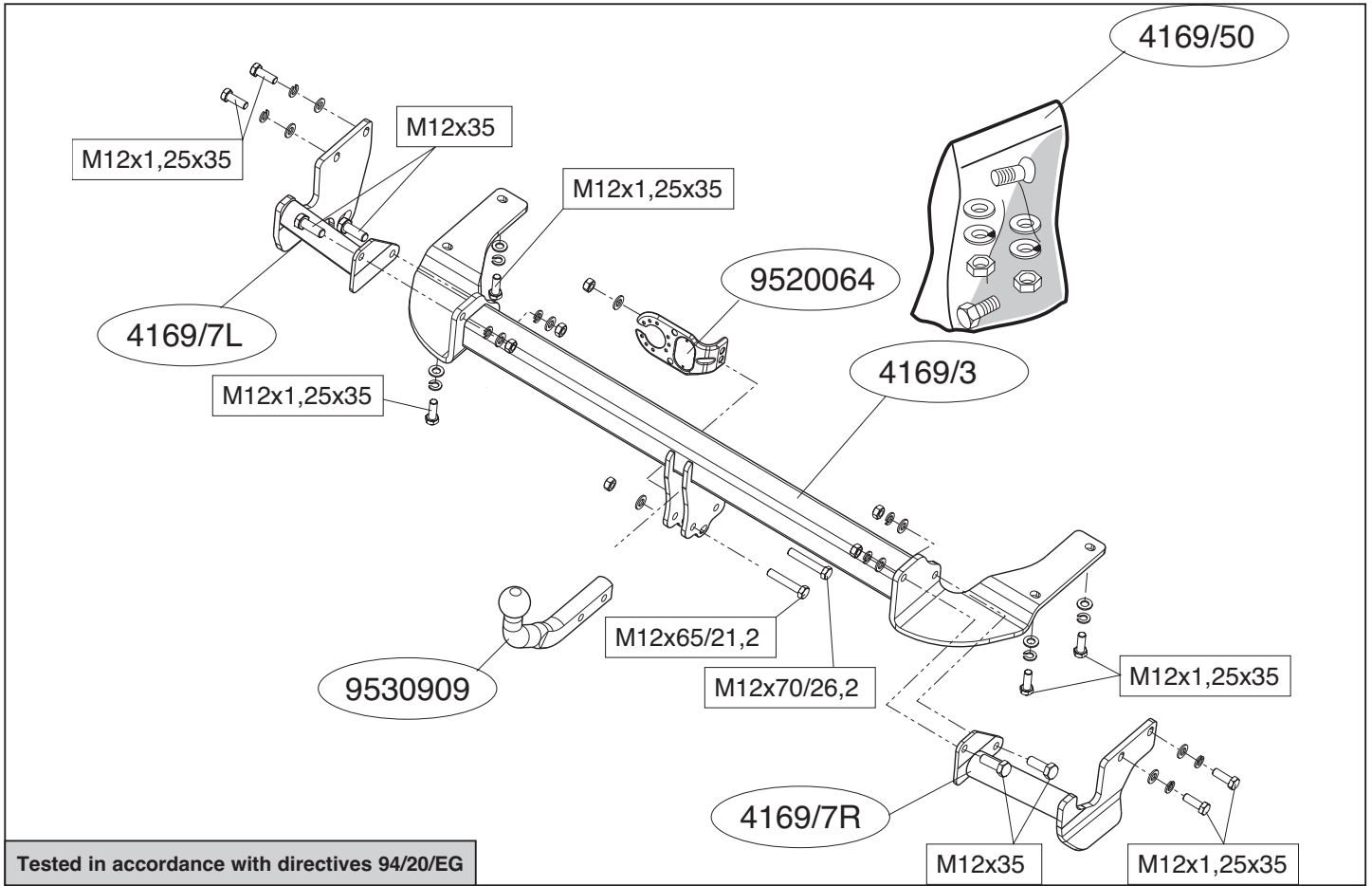

© 416970/10-03-2006/1

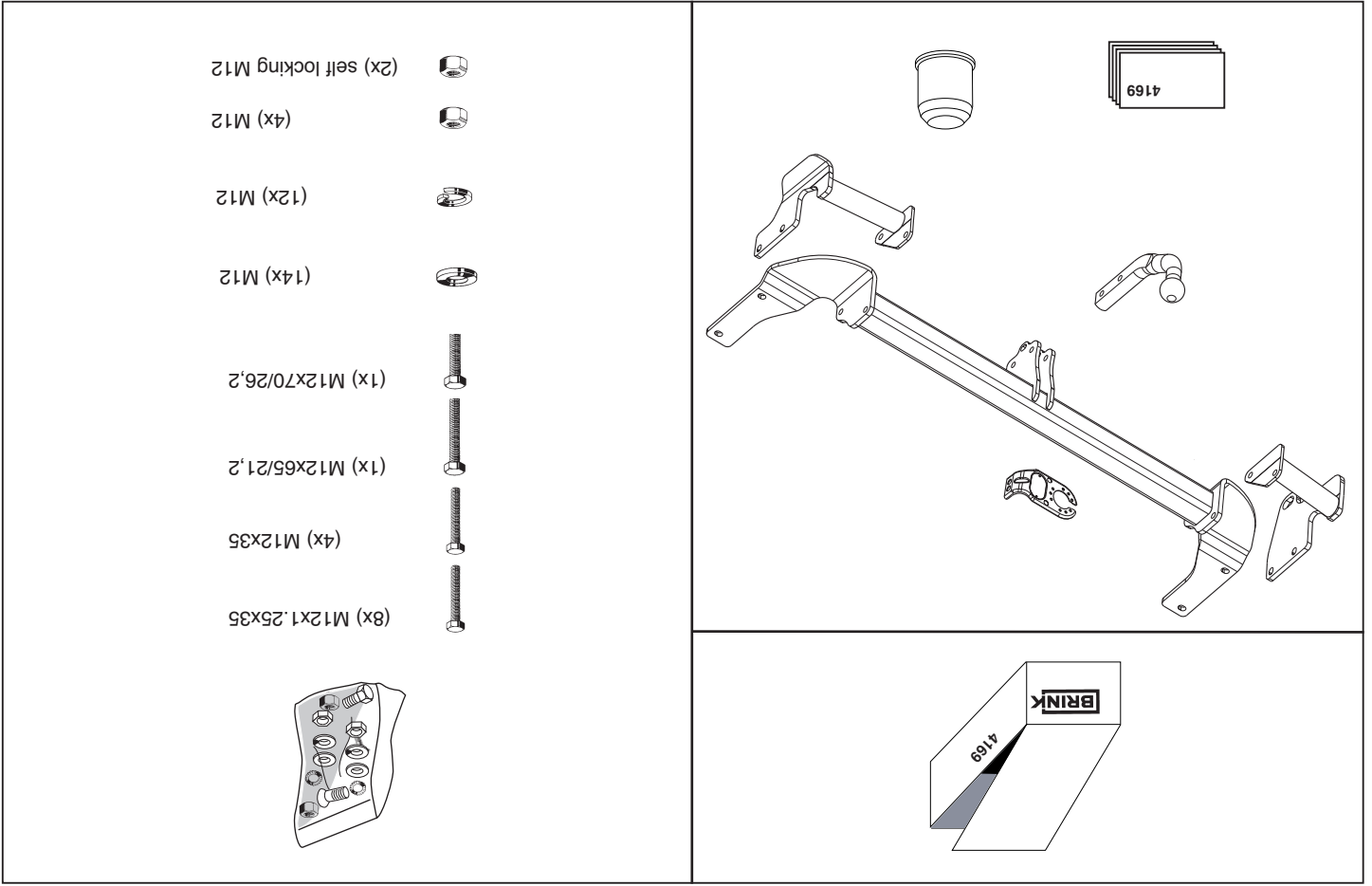

Per verificare l'idoneità del dispositivo di traino omologato a norma CEE 94/20, all'installazione sulla vettura su cui si intende procedere al montaggio, compilare la seguente formula (se necessario) declassare la massa rimorchiabile):

$$D = \frac{T \times C}{T + C} \times 0,00981 = \dots \text{KN}$$

dove: T = Massa Complessiva Max. della motrice (in kg)
 C = Massa Rimorchiabile Max. della motrice (in kg)

DA COMPILARE PER IL COLLAUDO

DICHIARAZIONE DI CORRETTO MONTAGGIO: la sottoscritta Ditta dichiara di aver montato in maniera corretta ed in conformità alle prescrizioni sia del costruttore del veicolo che del costruttore del dispositivo stesso il seguente dispositivo di attacco meccanico:

tipo:.....
 Il dispositivo di attacco sopra indicato è stato installato su autoveicolo
 modello:.....
 targa:.....
 Data:.....

Si dichiara inoltre di aver informato l'utente del veicolo sull'USO e MANUTENZIONE del dispositivo stesso.

TIMBRO e FIRMA

Dispositivo di traino tipo: 4169
 Per autoveicoli: Mitsubishi Grandis; 2004->
 Tipo funzionale:

Classe e tipo di attacco: A50-X
 Omologazione: e11 00-4719
 Valore D: 10,8 kN
 Carico Verticale max. S: 85 kg
 Larghezza rimorchiabile per Caravan e T.A.T.S.: 2,45m vedere CARTA di CIRCOLAZIONE VEICOLO (motrice) + 70 cm = ..arrotondare ai 5 cm
 superiore (vedi D.M.28/05/85)
 Massa rimorchiabile: vedi carta di circolazione dell' autoveicolo

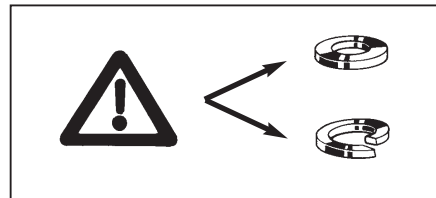
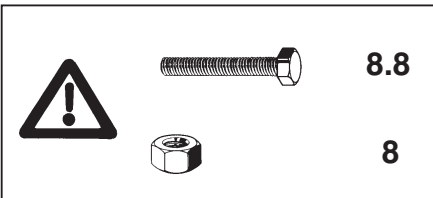
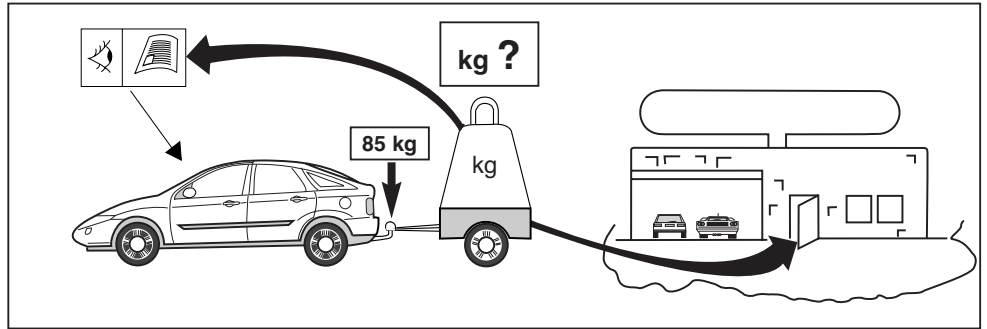
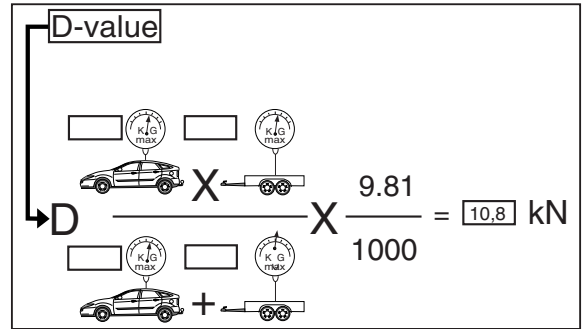
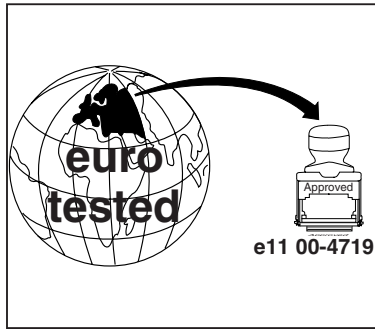
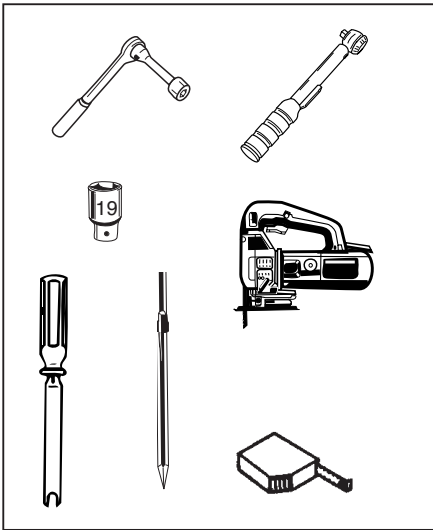

© 416970/10-03-2006/3

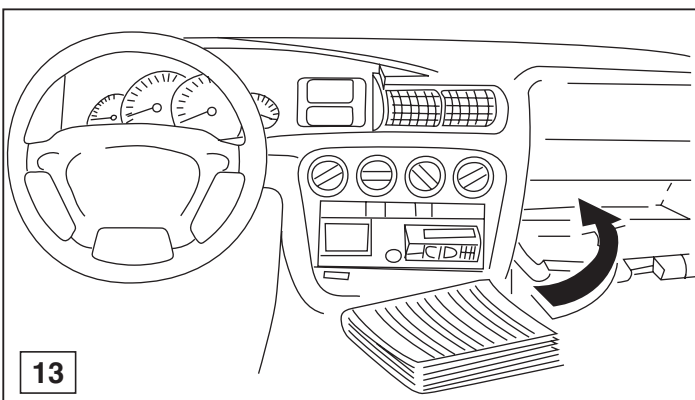
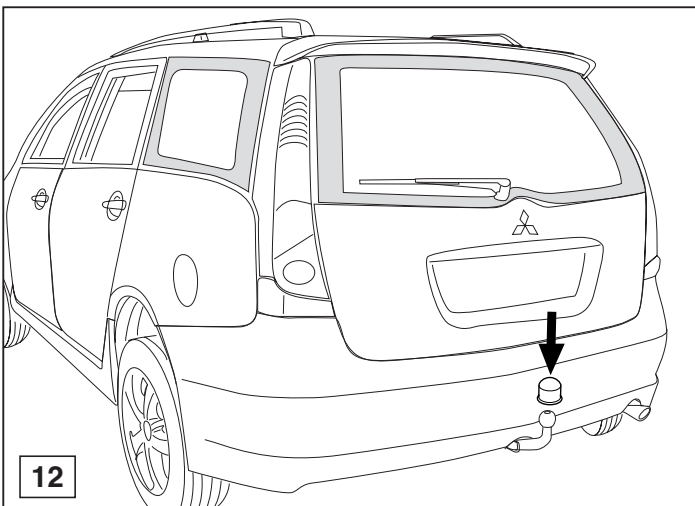



© 416970/10-03-2006/12

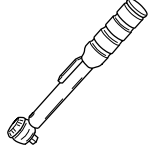

1000km

0km

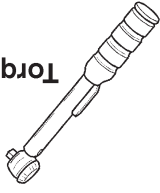

M12x1,25
95 Nm

M12
79 Nm (with self-locking nut)



Torque settings for nuts and bolts (8.8)

HINWEISE:

* Die für das Fahrzeug zugelassene Anhängelast ist den Fahrzeug Unterlagen zu entnehmen. Bei Änderungen des Fahrzeuggewichtes muß die höchstzulässige Anhängelast gegebenenfalls aus dem D-Wert nachgerechnet werden.

* Auskunft hierüber kann Ihr Fachhändler oder der TÜV geben.

* Elektrische Anlage gemäß StVZO anbringen.

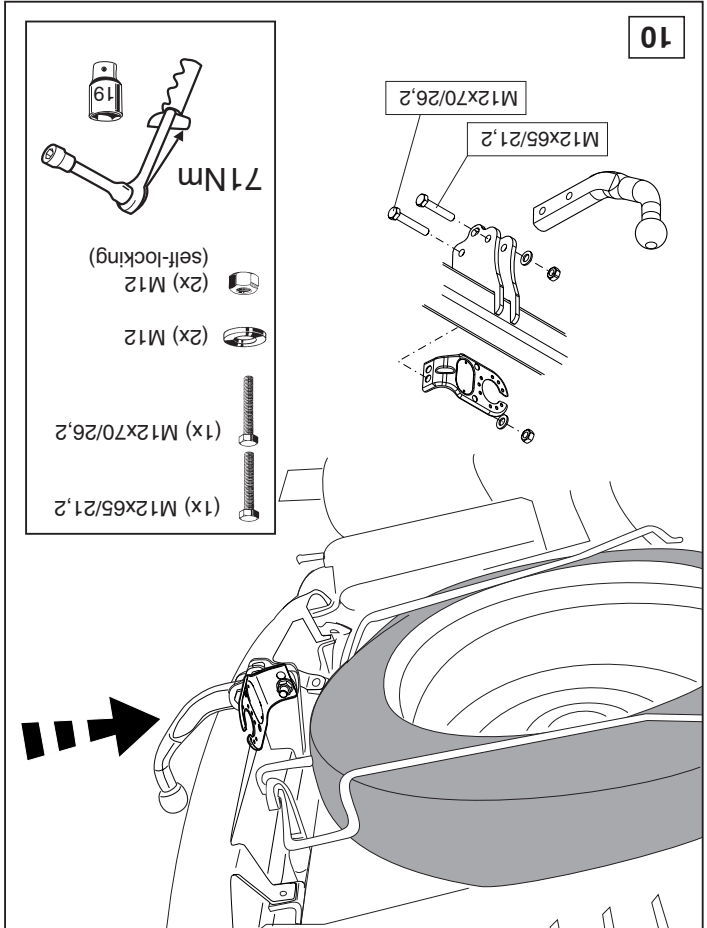
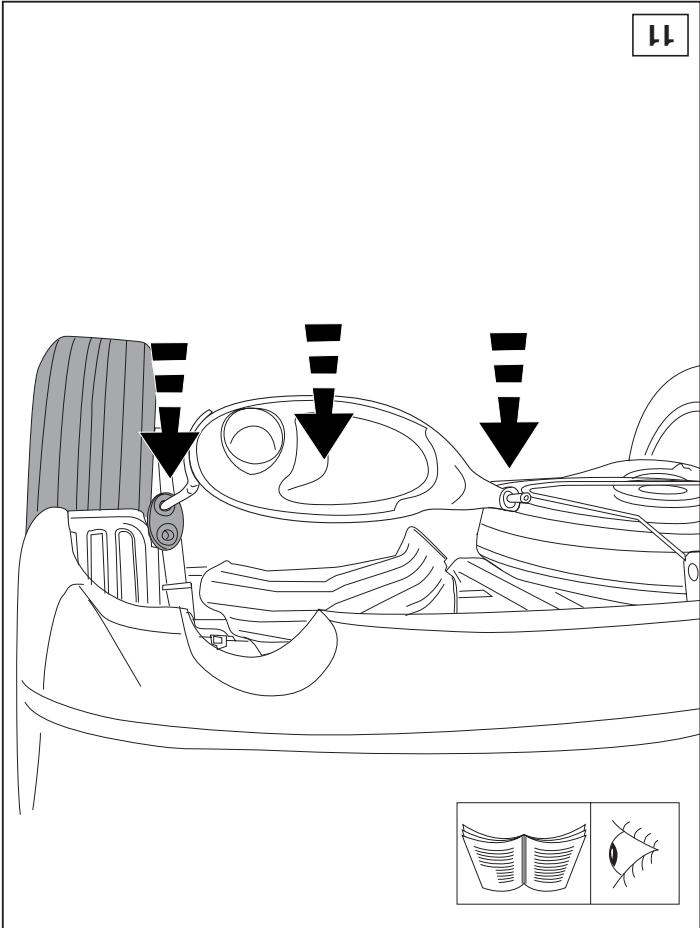

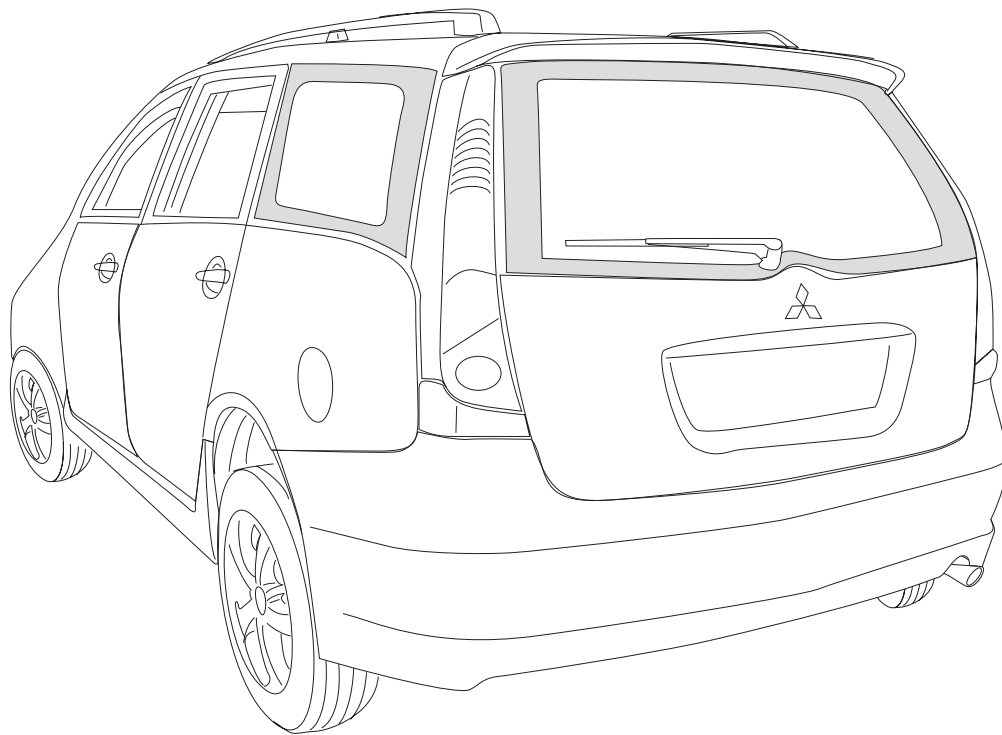

1

© 416970/10-03-2006/5

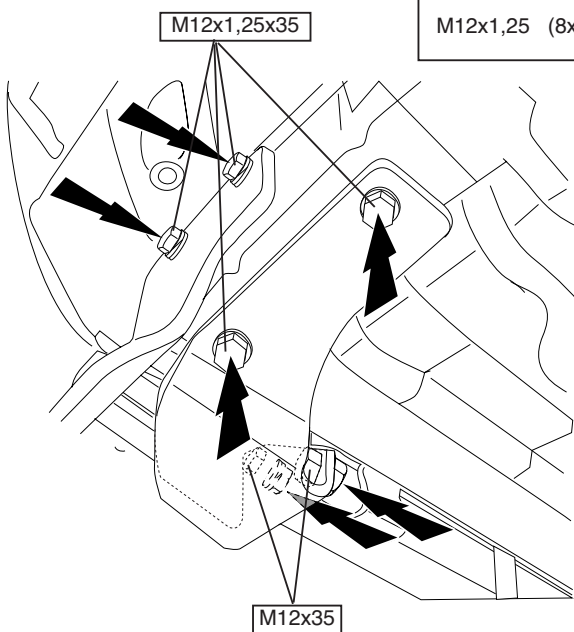
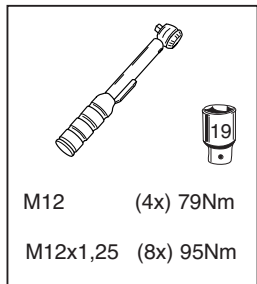
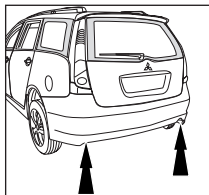

8

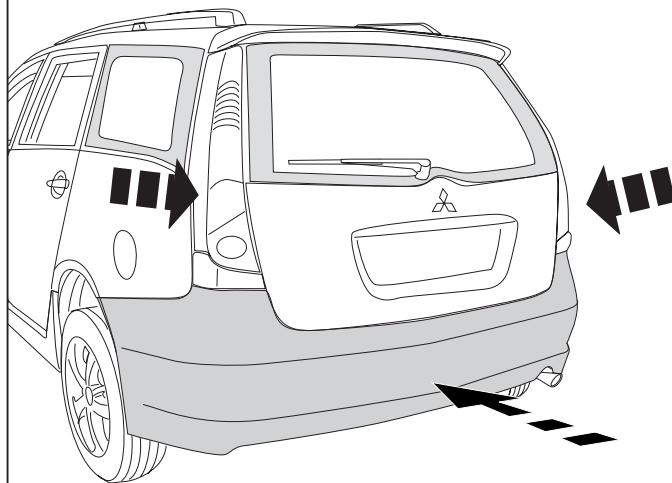
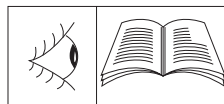

9

© 416970/10-03-2006/10

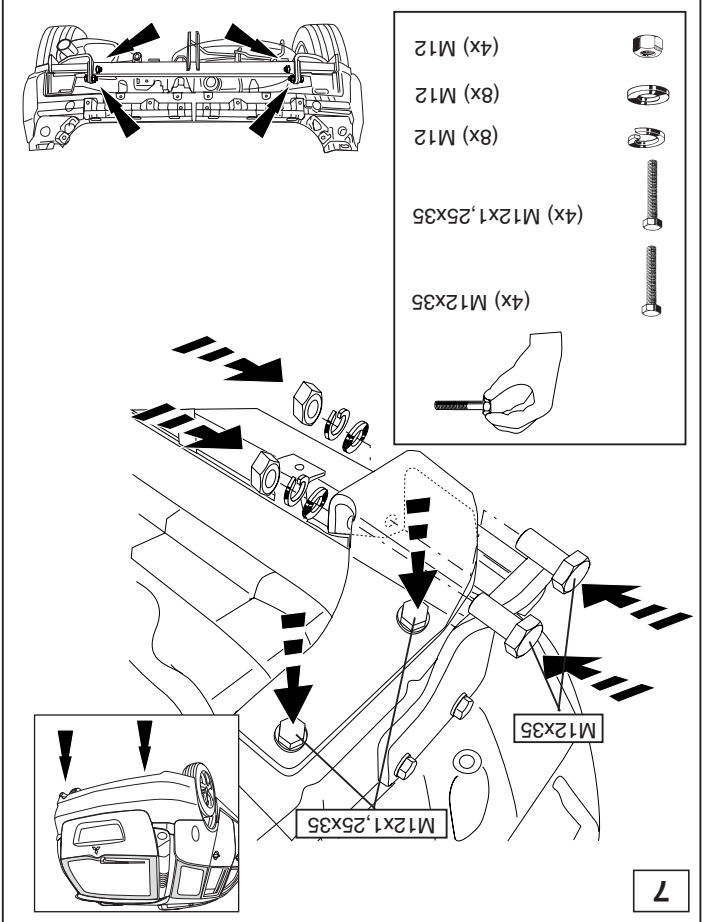
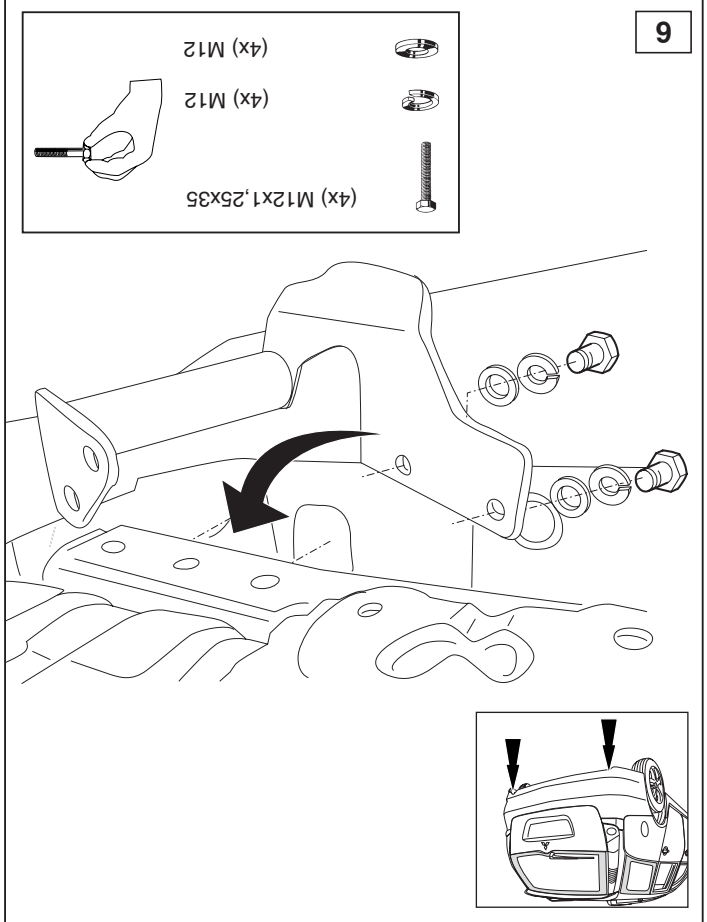
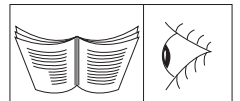
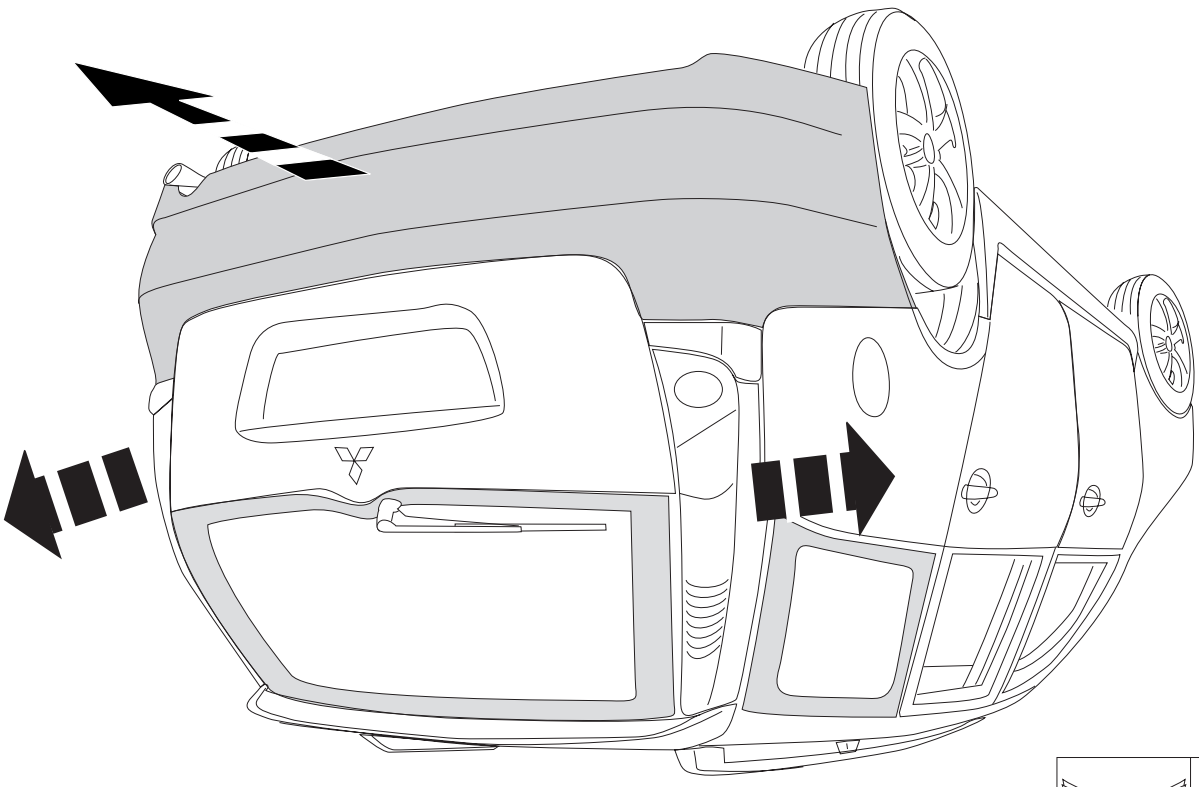

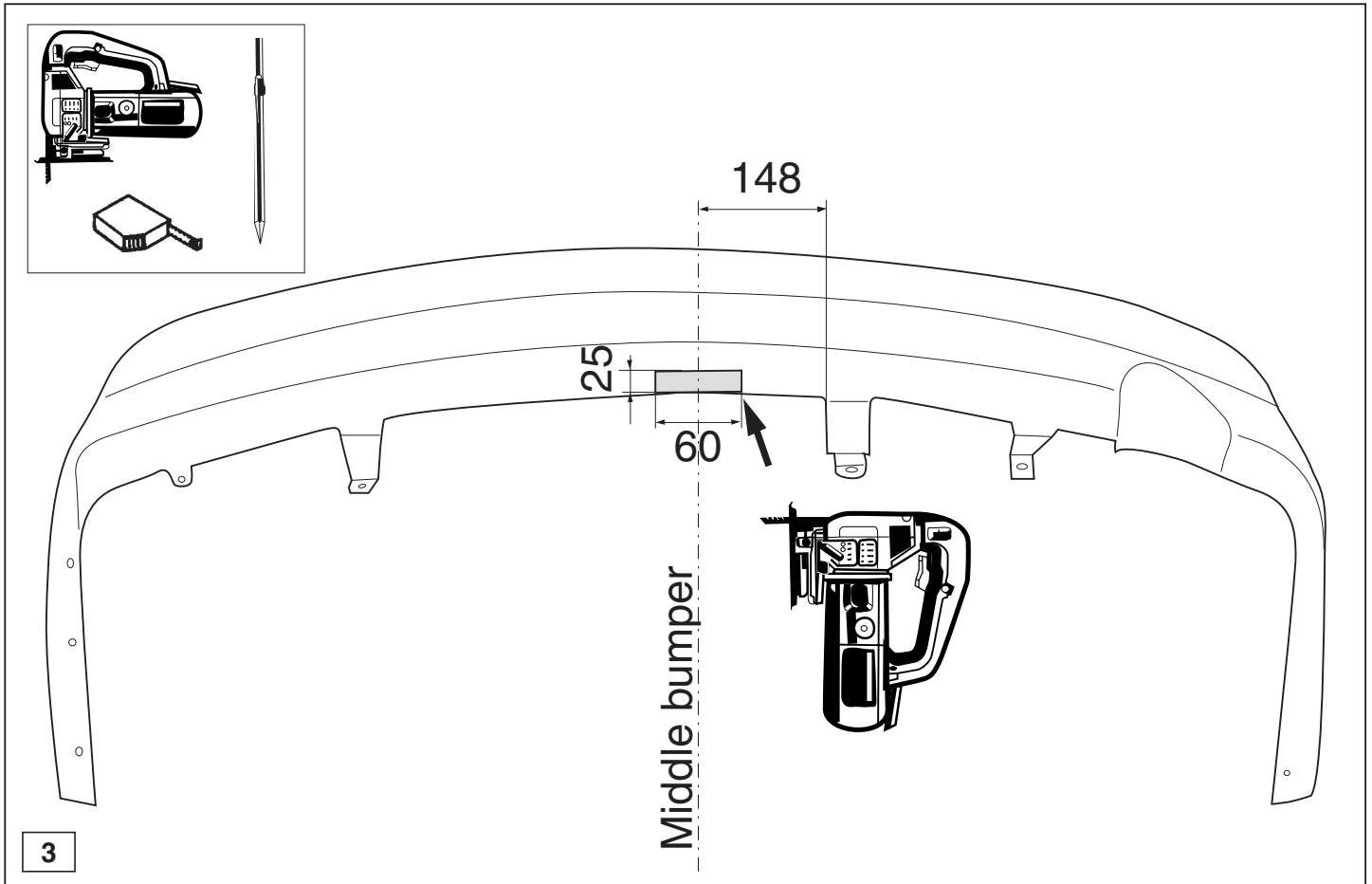

© 416970/10-03-2006/7

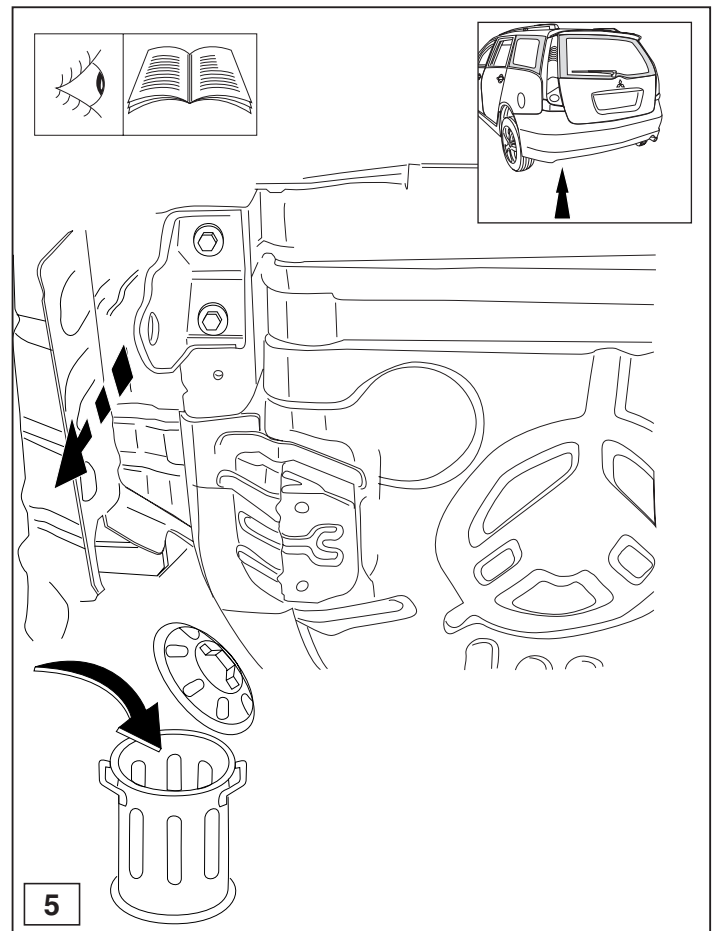
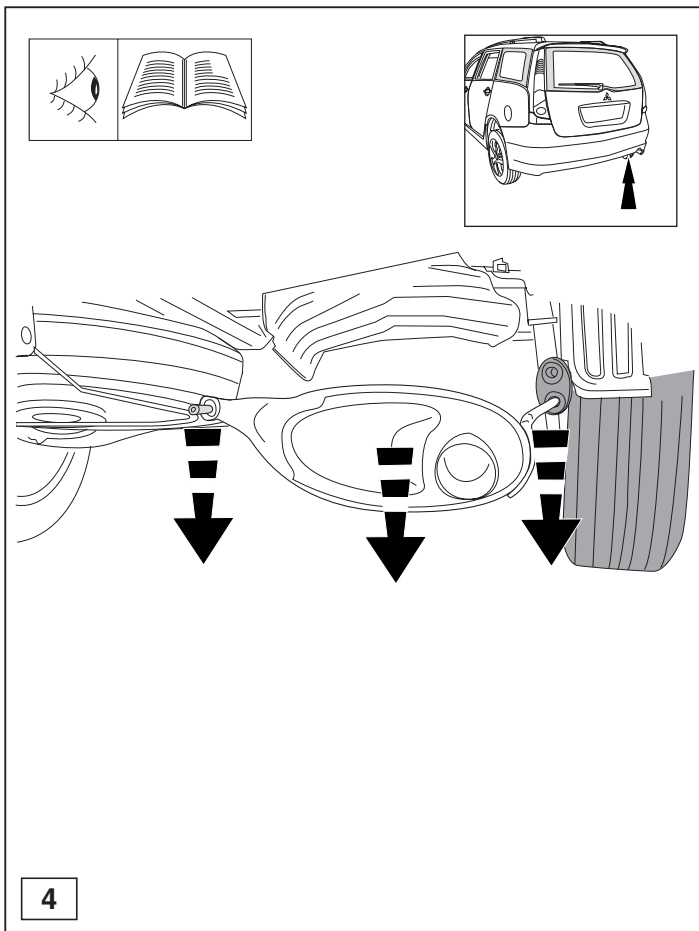

© 416970/10-03-2006/8